

FR/ Annexe  
PL/ Załącznik

ES/ Apéndice  
RU/ Приложение

PT/ Anexo  
UK/ Додаток

IT/ Appendice  
RO/ Anexa

EL/ Παράρτημα  
EN/ Appendix

Ean code	**Model No.	size(mm)	profile
3276000255741	MNE-AE7080-S-C	(700-800)×(700-800)×1850	silver
3276000248118	MNE-AE8090-S-C	(800-900)×(800-900)×1850	silver
3276000248125	MNE-AE8090-S-G	(800-900)×(800-900)×1850	silver
3276000254089	MNE-AE90100-S-C	(900-1000)×(900-1000)×1850	silver

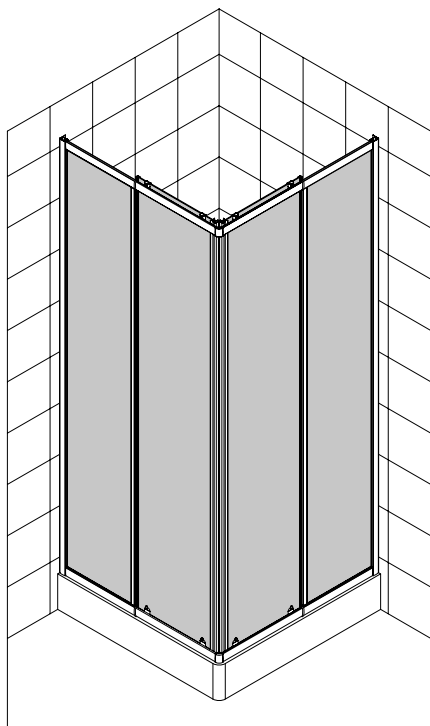

- FR** Notice de Montage, Utilisation, Entretien
- ES** Instrucciones de Montaje, Utilización y Mantenimiento
- PT** Instruções de Montagem, Utilização e Manutenção
- IT** Istruzioni per il Montaggio, l'Uso e la Manutenzione
- EL** Εγχειρίδιο συναρμολόγησης, χρήσης και συντήρησης
- PL** Instrukcja Montażu, Użytkowania i Konserwacji
- RU** Руководство По Сборке и Эксплуатации
- UK** Керівництво По Збірці і Експлуатації
- RO** Manual asamblare, utilizare și întreținere
- EN** Assembly - Use - Maintenance Manual



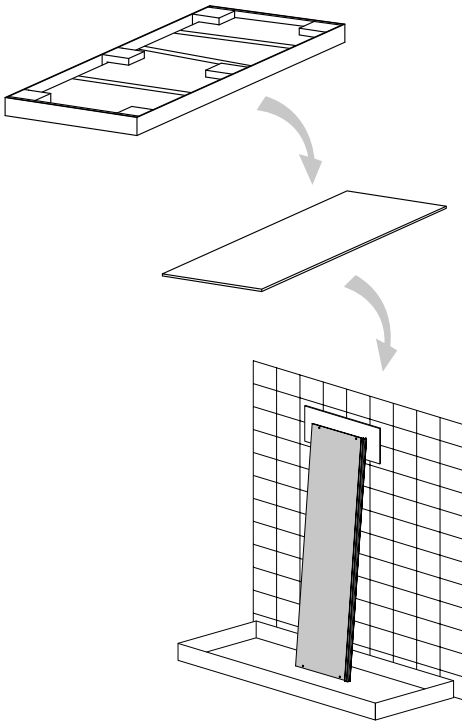
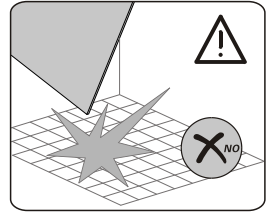
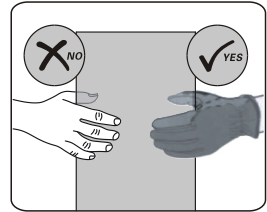
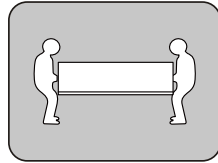
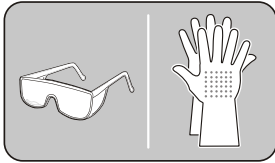
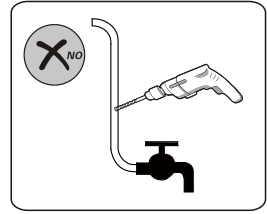
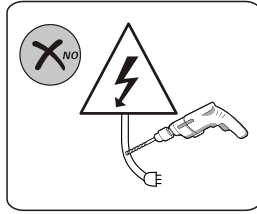
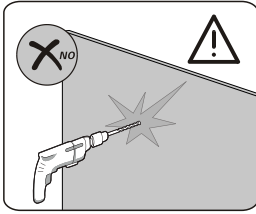

**FR** Vérifiez que les chevilles murales fournies sont appropriées à votre mur (celles fournies dans l'emballage sont conçues pour le béton). Sinon, utilisez des vis et des chevilles murales adaptées au type de matériau de votre mur. Pour obtenir des conseils concernant les vis et les chevilles appropriées à votre mur, demandez à un vendeur spécialisé.

**ES** Compruebe que todos los tacos suministrados puedan ser utilizados con su pared (los incluidos en la caja son para hormigón). En caso contrario, utilice tornillos y tacos de pared apropiados para el material de su pared. Para información acerca de las fijaciones y tornillos apropiados para su pared, consulte con un asistente de ventas especializado.

**PT** Certifique-se de que as buchas fornecidas são adequadas à sua parede (as fornecidas na embalagem são para betão). Caso contrário, utilize parafusos e buchas adequados ao tipo de material da sua parede. Para se aconselhar acerca dos parafusos e buchas adequados à sua parede, fale com um assistente de vendas especializado.

**IT** Verificare che i tasselli da parete forniti siano compatibili con la propria parete (quelli forniti con l'articolo sono per cemento). Altrimenti, utilizzare viti e tasselli adatti per la superficie della propria parete. Per ottenere consigli e suggerimenti sulle viti e i tasselli più adatti alla propria parete, consultare un rivenditore specializzato.

**EL** Βεβαιωθείτε ότι οι παρεχόμενες στερεώσεις τοίχου είναι κατάλληλες για τον τοίχο σας (οι παρεχόμενες στη συσκευή προορίζονται για μπετό). Αλλιώς χρησιμοποιήστε βίδες και στερεώσεις τοίχου κατάλληλες για τον τύπο υλικού του τοίχου σας. Για να λάβετε συμβουλές σχετικά με τις κατάλληλες βίδες και τα εξαρτήματα για τον τοίχο σας, ρωτήστε έναν ειδικό πωλητή.

**PL** Prosimy sprawdzić, czy dostarczone kolki do ścian nadają się do użycia w posiadanej ścianie (kolki dostarczone w zestawie są przeznaczone do betonu). Jeśli tak nie jest, należy użyć śrub i kolków odpowiednich do materiału, z którego wykonana jest ściana. Aby uzyskać poradę w sprawie śrub i elementów montażowych odpowiednich do danego typu ściany, należy zwrócić się z pytaniem do wyspecjalizowanego sprzedawcy.

**RU** Убедитесь, что прилагаемые дюбеля подходят для ваших стен (входящие в комплект дюбеля предназначены для бетона). В противном случае используйте шурупы и дюбеля, соответствующие материалу стены. Для получения рекомендаций по выбору шурупов и крепежных деталей, подходящих для вашей стены, обратитесь к специалисту-консультанту.

**UK** Перевірте, що анкери підходять для вашої стіни (ті, що постачаються в упаковці – для бетону). В іншому випадку використовуйте гвинти й стінові анкери, що відповідають матеріалу вашої стіни. Для отримання консультацій щодо гвинтів й фітінгів для вашої стіни зверніться до відповідного продавця-консультанта.

**RO** Verificați ca toate ancorele de perete furnizate să fie adecvate pentru peretele dumneavoastră (cele furnizate în pachet sunt pentru beton). În caz contrar, folosiți șuruburi și ancore de perete adecvate pentru tipul de material din care este peretele dumneavoastră. Pentru a obține recomandări privind șuruburile și armăturile adecvate pentru peretele dumneavoastră, întrebați un vânzător specializat.

**EN** Check that wall anchors provided are suitable for your wall (those provided in the package are for concrete). Otherwise, use screws and wall anchors suited to the type of material of your wall. To obtain advice on the screws and fittings suited to your wall, ask a specialized sales assistant.



FR Préparation

ES Preparación

PT Preparação

IT Preparazione

EL Προετοιμασία

PL Przygotowanie

RU Подготовка

UK Підготовка

RO Pregătire

EN Preparation

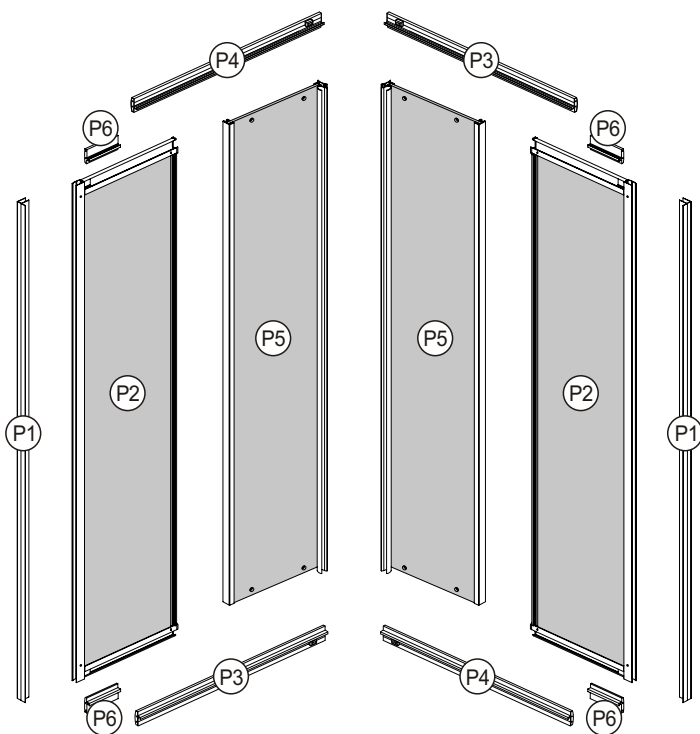
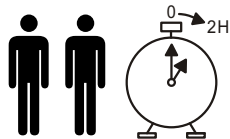
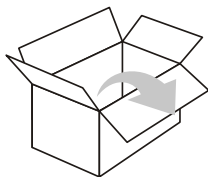

FR Préparation

ES Preparación

PT Preparação

IT Preparazione

EL Προετοιμασία

PL Przygotowanie

RU Подготовка

UK Підготування

RO Pregătire

EN Preparation

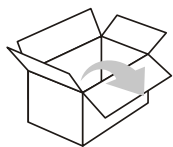

H1 x6



4x30mm

H2 x4



H3 x4



H4 x6



6x30mm

H5 x6



5x10mm

H6 x6



7x12mm

H7 x6



4x12mm

H8 x6



6x9mm

H10 x2

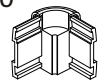

x2

x4

H12 x4



4x7mm

H13 x2

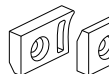

x2



x4

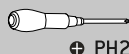
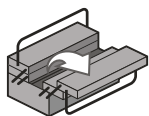

PH2

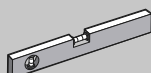
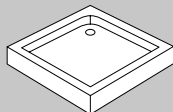
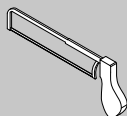

∅6mm

∅3mm

Not Included  
brak w zestawie

non inclus  
no incluido



δεν συμπεριλαμβάνονται  
не входит до комплекта

Não incluído  
neinclus

non incluso  
Dahil deǵildir

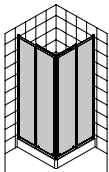
Не входит в комплект

**FR** Montage**ES** Montaje**PT** Montagem**IT** Montaggio**EL** Συναρμολόγηση**PL** Montaż**RU** Сборка**UK** Збірка**RO** Montaj**EN** Assembly**1**

	NEREA	A(mm)	B(mm)
	(700-800) × (700-800)mm	790-X	790-Y
	(800-900) × (800-900)mm	890-X	890-Y
	(900-1000) × (900-1000)mm	990-X	990-Y

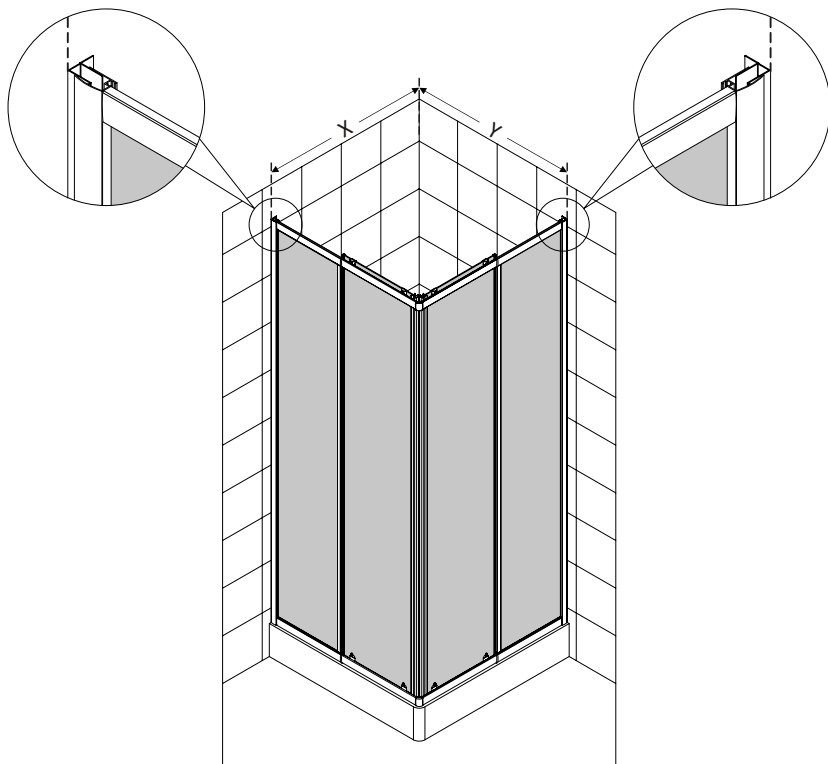



FR Montage

ES Montaje

PT Montagem

IT Montaggio

EL Συναρμολόγηση

PL Montaż

RU Сборка

UK Збірка

RO Montaj

EN Assembly

2

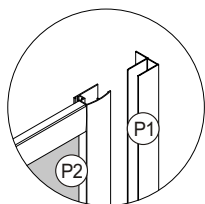
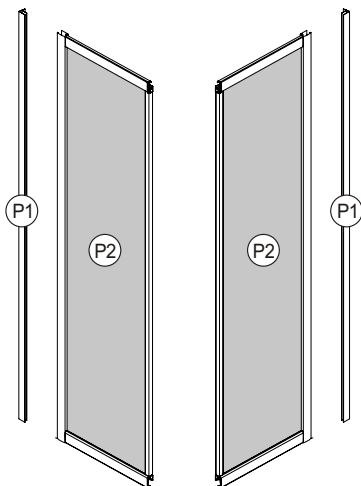
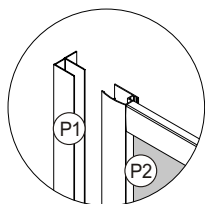
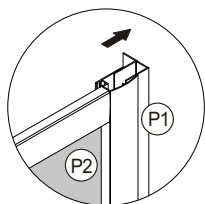
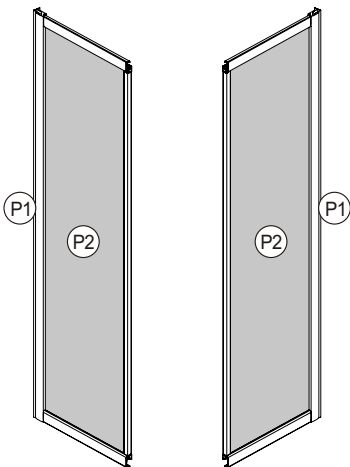
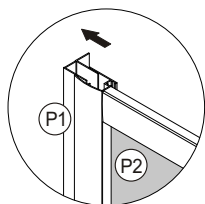
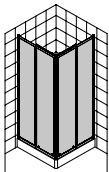

FR Montage

ES Montaje

PT Montagem

IT Montaggio

EL Συναρμολόγηση

PL Montaż

RU Сборка

UK Збірка

RO Montaj

EN Assembly

3

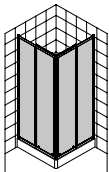

	NEREA	A(mm)	B(mm)
	(700-800) × (700-800)mm	790-X	790-Y
	(800-900) × (800-900)mm	890-X	890-Y
	(900-1000) × (900-1000)mm	990-X	990-Y

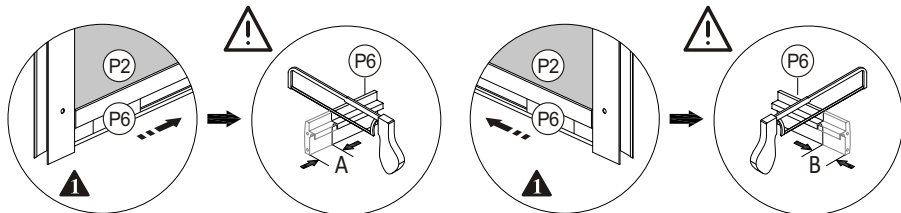
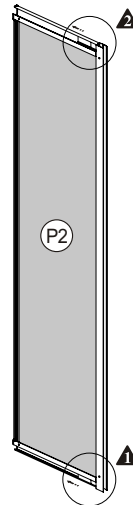
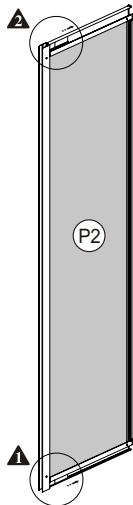
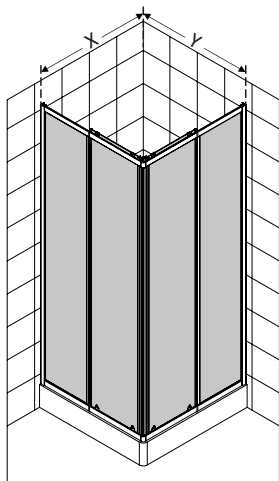
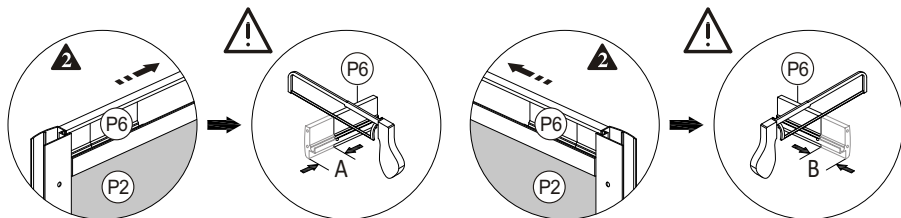
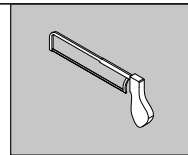

FR Montage

ES Montaje

PT Montagem

IT Montaggio

EL Συναρμολόγηση

PL Montaż

RU Сборка

UK Збірка

RO Montaj

EN Assembly

4

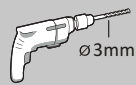
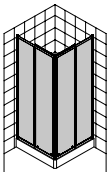

∅3mm



PH2

H12 x2



4x7mm

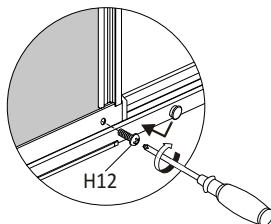
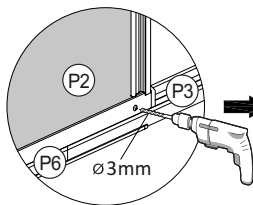
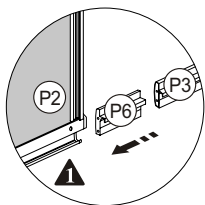
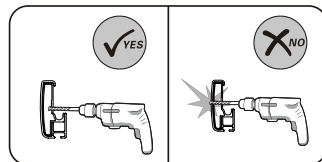
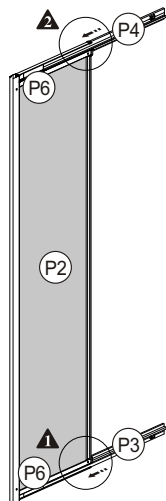
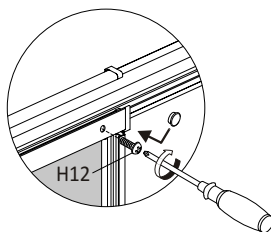
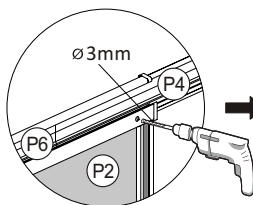
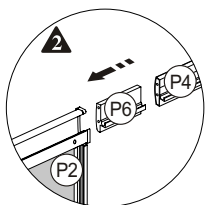

FR Montage

ES Montaje

PT Montagem

IT Montaggio

EL Συναρμολόγηση

PL Montaż

RU Сборка

UK Збірка

RO Montaj

EN Assembly

5

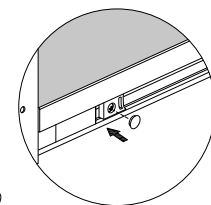
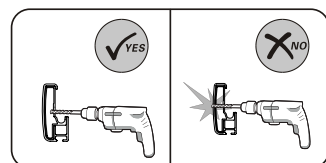
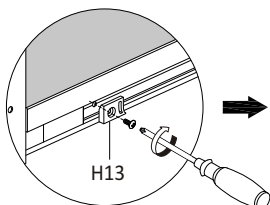
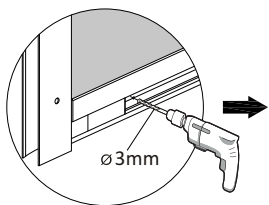
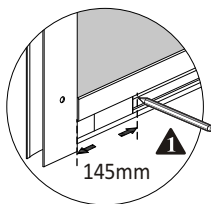
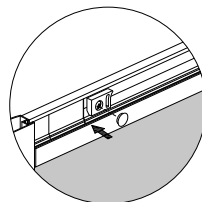
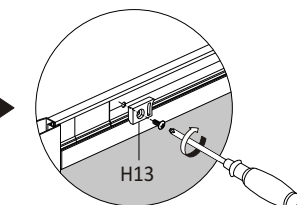
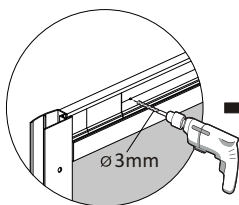
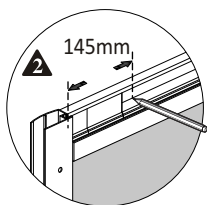
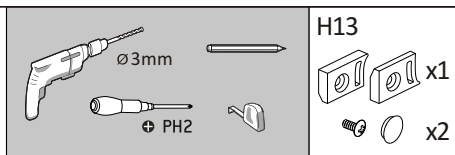
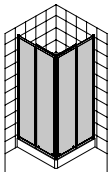

FR Montage

ES Montaje

PT Montagem

IT Montaggio

EL Συναρμολόγηση

PL Montaż

RU Сборка

UK Збірка

RO Montaj

EN Assembly

6

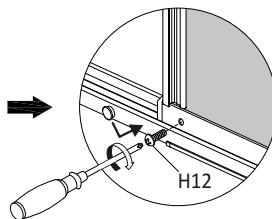
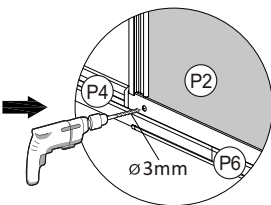
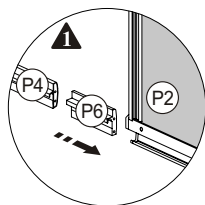
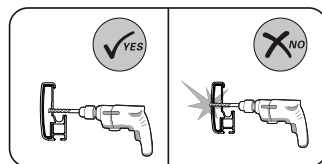
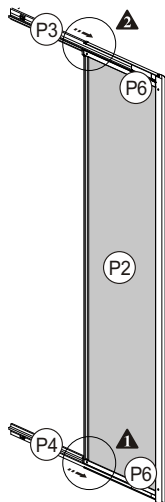
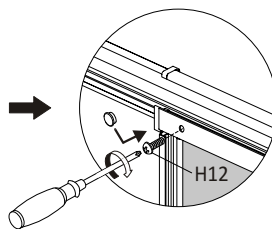
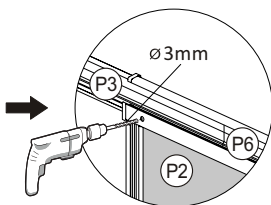
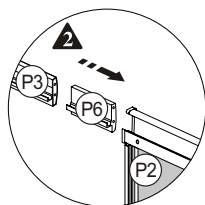
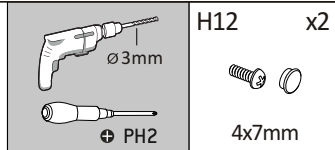
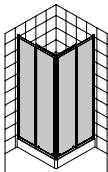

FR Montage

ES Montaje

PT Montagem

IT Montaggio

EL Συναρμολόγηση

PL Montaż

RU Сборка

UK Збірка

RO Montaj

EN Assembly

7

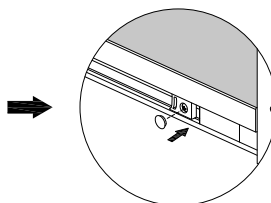
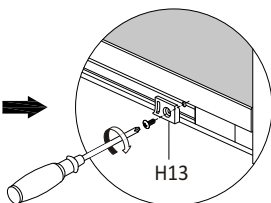
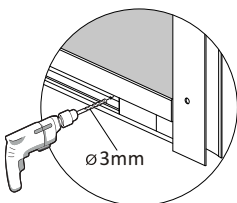
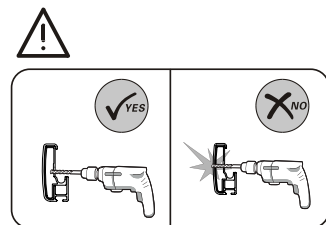
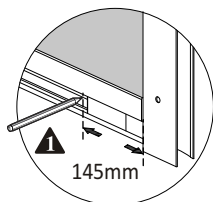
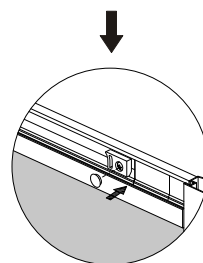
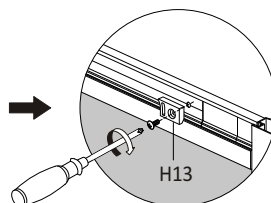
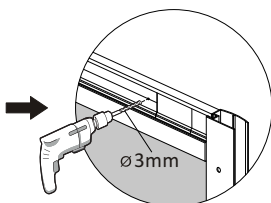
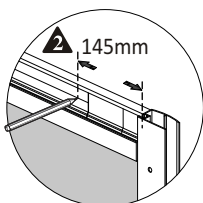
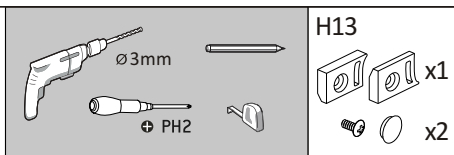
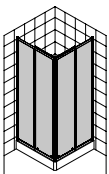

FR Montage

ES Montaje

PT Montagem

IT Montaggio

EL Συναρμολόγηση

PL Montaż

RU Сборка

UK Збірка

RO Montaj

EN Assembly

8

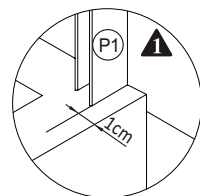
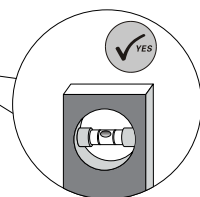
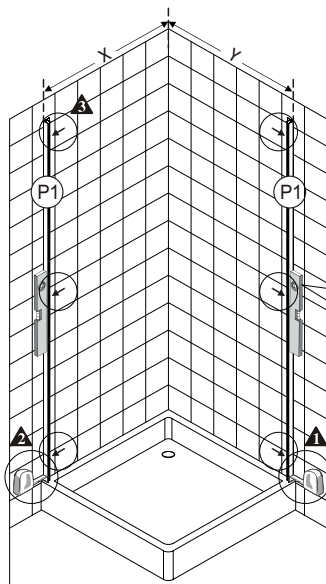
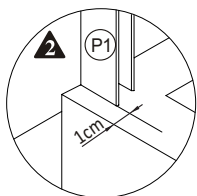
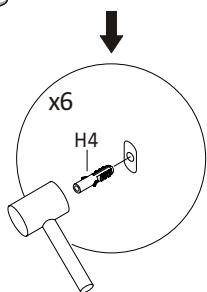
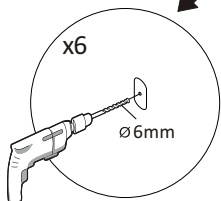
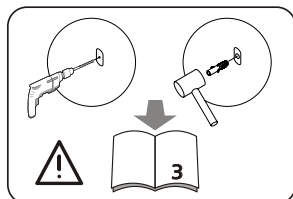
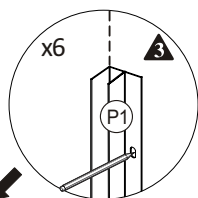
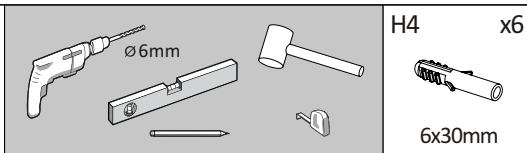
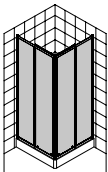

FR Montage

ES Montaje

PT Montagem

IT Montaggio

EL Συναρμολόγηση

PL Montaż

RU Сборка

UK Збірка

RO Montaj

EN Assembly

9

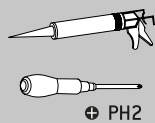
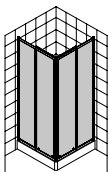

H1 x6



4x30mm

H5 x6



5x10mm

H6 x6



7x12mm

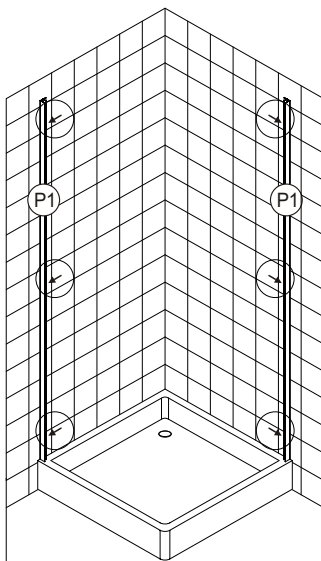
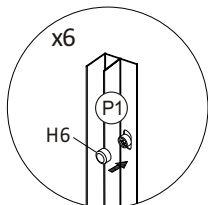
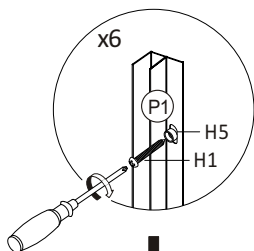
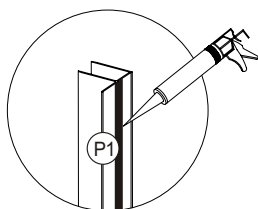



FR Montage

ES Montaje

PT Montagem

IT Montaggio

EL Συναρμολόγηση

PL Montaż

RU Сборка

UK Збірка

RO Montaj

EN Assembly

10

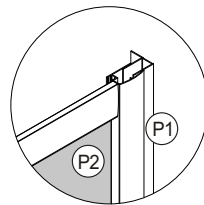
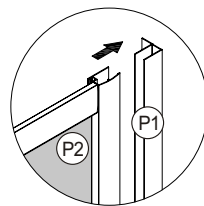
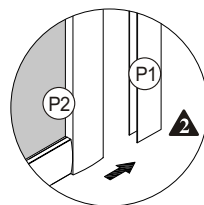
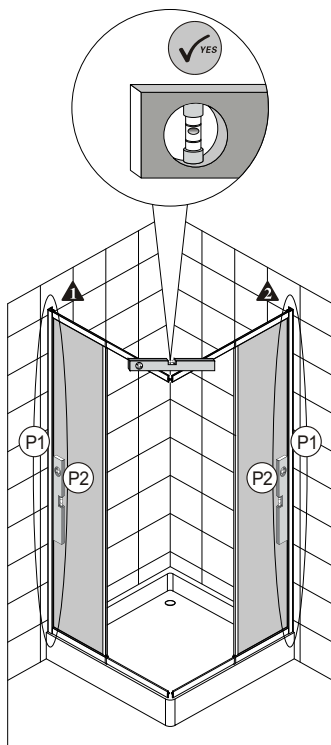
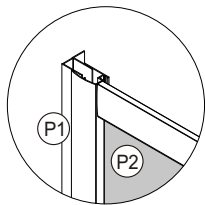
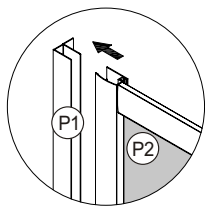
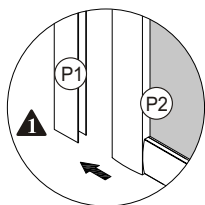
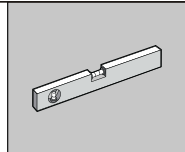
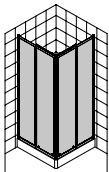

FR Montage

ES Montaje

PT Montagem

IT Montaggio

EL Συναρμολόγηση

PL Montaż

RU Сборка

UK Збірка

RO Montaj

EN Assembly

11

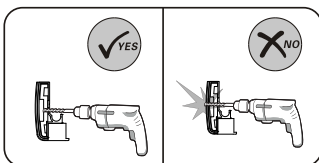
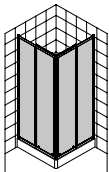

H10



x2

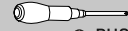

⊕ PH2

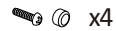

x4

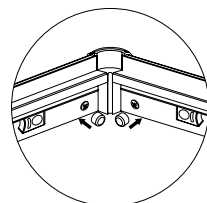
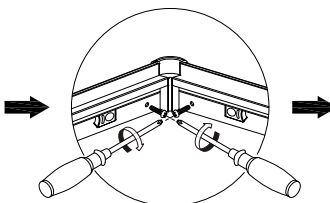
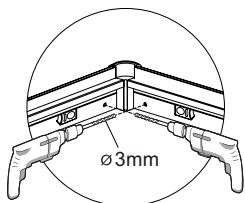
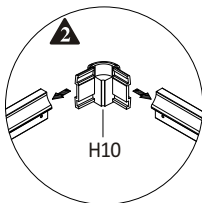
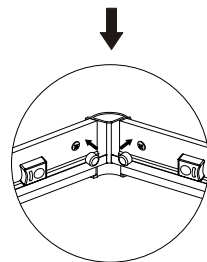
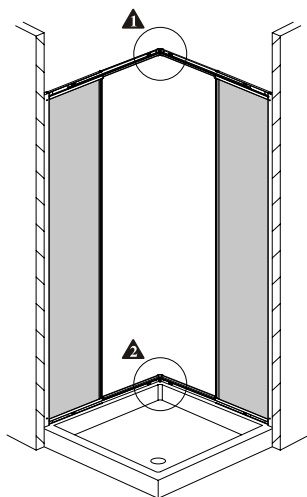
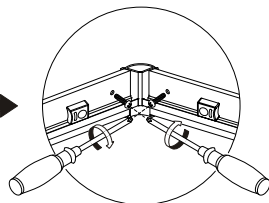
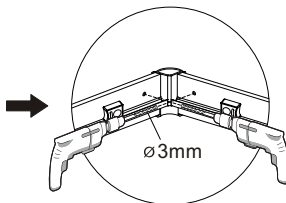
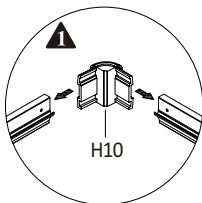

FR Montage

ES Montaje

PT Montagem

IT Montaggio

EL Συναρμολόγηση

PL Montaż

RU Сборка

UK Збірка

RO Montaj

EN Assembly

12

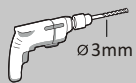
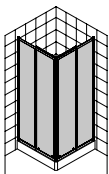

Ø3mm

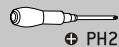

PH2

H7 x6



4x12mm

H8 x6



6x9mm

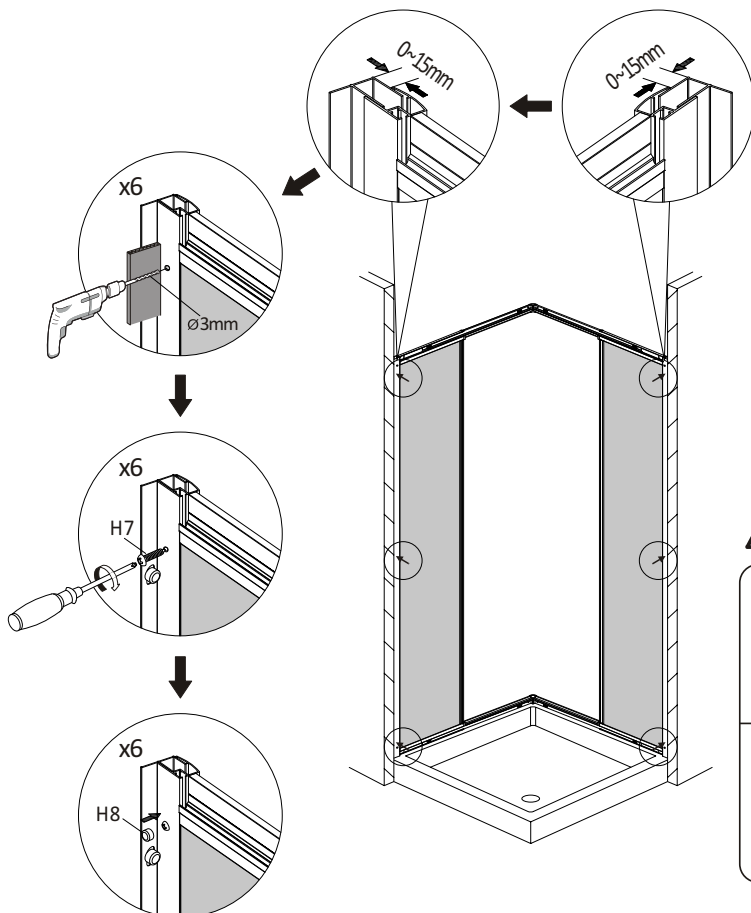

FR Montage

ES Montaje

PT Montagem

IT Montaggio

EL Συναρμολόγηση

PL Montaż

RU Сборка

UK Збірка

RO Montaj

EN Assembly

13

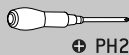
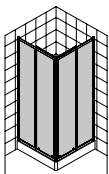

PH2

H2 x2



H3 x2

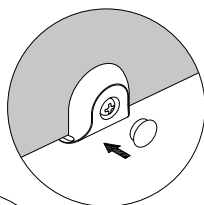
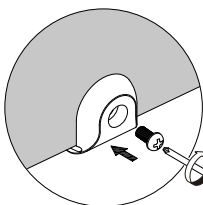
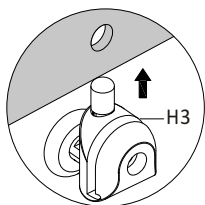
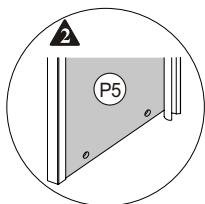
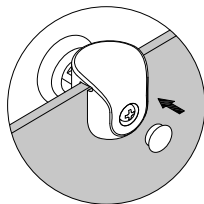
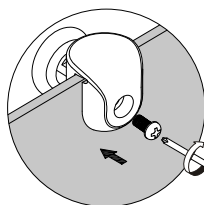
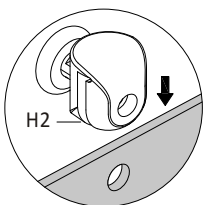
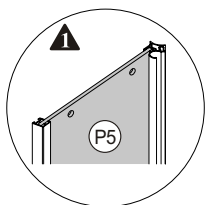

FR Montage

ES Montaje

PT Montagem

IT Montaggio

EL Συναρμολόγηση

PL Montaż

RU Сборка

UK Збірка

RO Montaj

EN Assembly

14

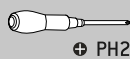
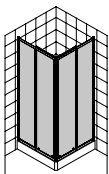

H2 x2



H3 x2

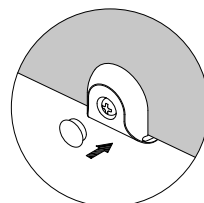
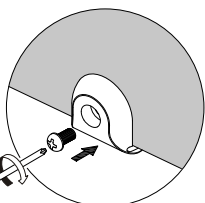
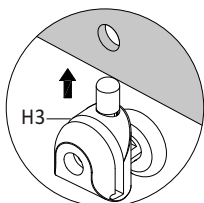
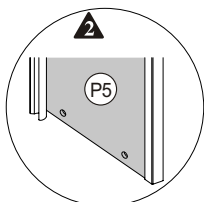
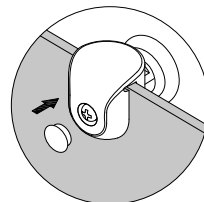
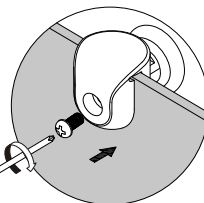
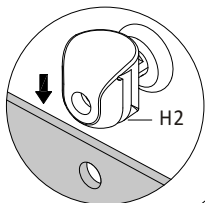
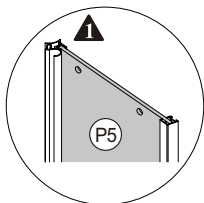

FR Montage

ES Montaje

PT Montagem

IT Montaggio

EL Συναρμολόγηση

PL Montaż

RU Сборка

UK Збірка

RO Montaj

EN Assembly

15

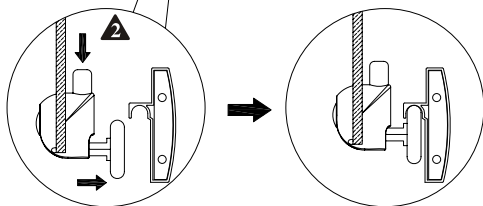
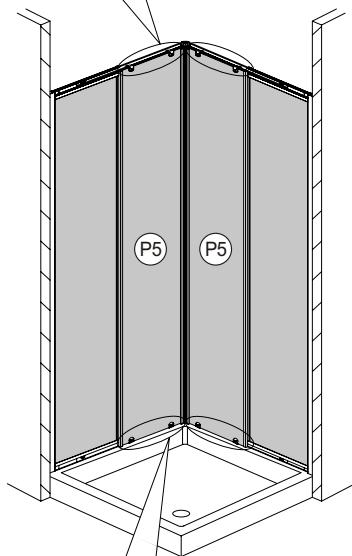
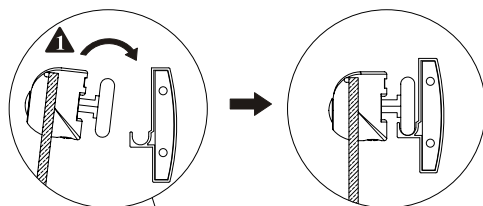
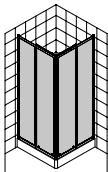

FR Montage

ES Montaje

PT Montagem

IT Montaggio

EL Συναρμολόγηση

PL Montaż

RU Сборка

UK Збірка

RO Montaj

EN Assembly

16

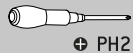
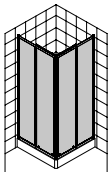

PH2

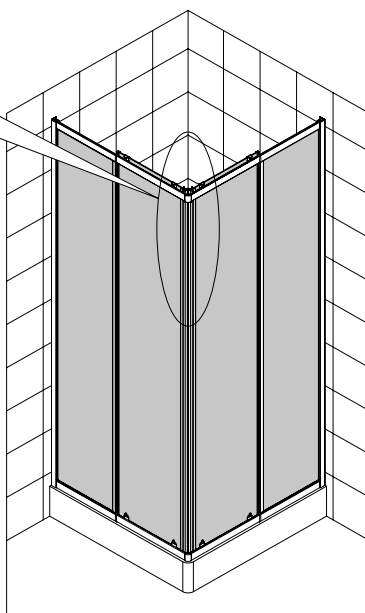
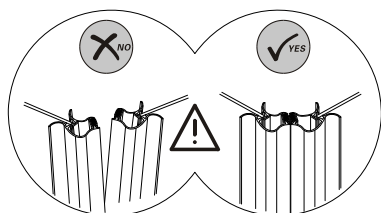
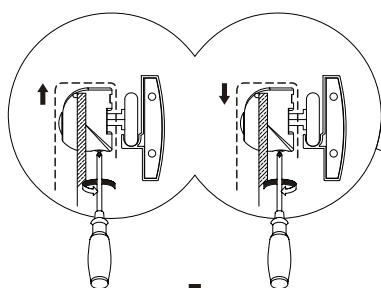

FR Montage

ES Montaje

PT Montagem

IT Montaggio

EL Συναρμολόγηση

PL Montaż

RU Сборка

UK Збірка

RO Montaj

EN Assembly

17

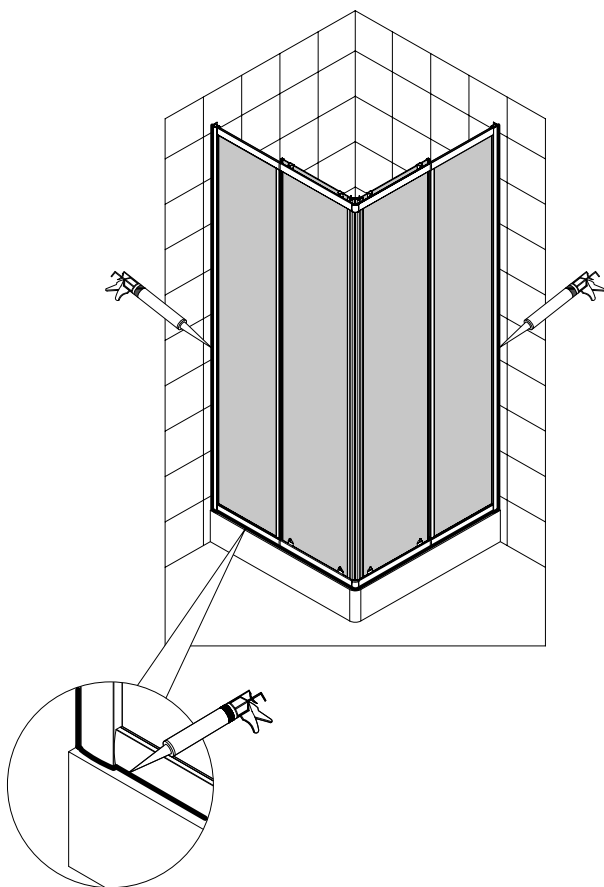
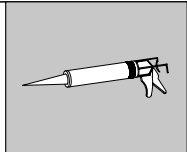
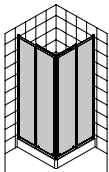



FR Entretien

ES Mantenimiento

PT Serviço

IT Manutenzione

EL Συντήρηση

PL Konserwacja

RU Уход

UK Догляд

RO Întreținere

EN Maintenance



Sans solvant / Sin disolvente / Sem solventes / Senza solventi / Χωρίς διαλυτικά / Bez rozpuszczalnika / Без растворителя / Без розчинника / Fără solvent / Solvent-free

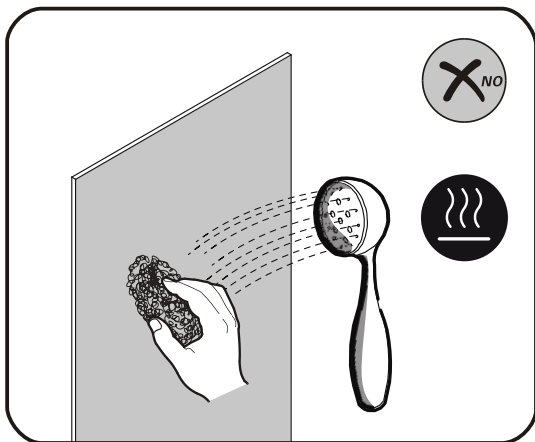
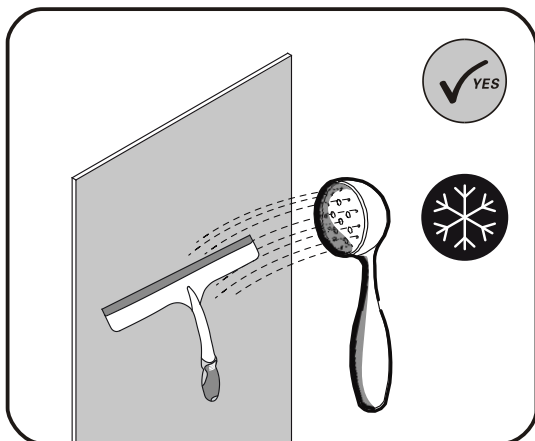

**FR**



ADEO Services -135 Rue Sadi Carnot -  
CS 00001 59790 RONCHIN - France  
16  
EN 14428:2015

Code d'identification unique  
du produit type: \*\*  
usage prévu: hygiène personnelle  
Nettoyable: Conforme  
Résistance à l'impact/  
Capacité de Fragmentation: Conforme  
durabilité: Conforme

DOP N° 207919/0020/2016

**ES**



ADEO Services -135 Rue Sadi Carnot -  
CS 00001 59790 RONCHIN - France  
16  
EN 14428:2015

Código de identificación  
única del producto tipo: \*\*  
Uso previsto: higiene personal  
Limpiable: Conforme  
Resistencia al impacto/  
Capacidad de fragmentación: Conforme  
Durabilidad: Conforme

DOP N° 207919/0020/2016

**PT**



ADEO Services -135 Rue Sadi Carnot -  
CS 00001 59790 RONCHIN - France  
16  
EN 14428:2015

Código de identificação  
único do produto-tipo: \*\*  
Utilização prevista: higiene pessoal  
Limpeza: Conforme  
Resistência ao impacto/  
Capacidade de fragmentação: Conforme  
Durabilidade: Conforme

DOP N° 207919/0020/2016

**IT**



ADEO Services -135 Rue Sadi Carnot -  
CS 00001 59790 RONCHIN - France  
16  
EN 14428:2015

Codice di identificazione  
unico del prodotto-tipo: \*\*  
Uso previsto: igiene personale  
Pulibile: Conforme  
Resistenza agli urti/  
Capacità di Frammentazione: Conforme  
Durata: Conforme

DOP N° 207919/0020/2016

**EL**



ADEO Services -135 Rue Sadi Carnot -  
CS 00001 59790 RONCHIN - France  
16  
EN 14428:2015

Μοναδικός κωδικός ταυτοποίησης  
του τύπου του προϊόντος: \*\*  
προβλεπόμενη χρήση: προσωπική υγιεινή  
Δυνατότητα καθαρισμού: Σύμφωνα με  
Αντοχή σε κρούση/ Ικανότητα κατάτμησης: Σύμφωνα με  
Διάρκεια: Σύμφωνα με

DOP N° 207919/0020/2016

**PL**



ADEO Services -135 Rue Sadi Carnot -  
CS 00001 59790 RONCHIN - France  
16  
EN 14428:2015

Niepowtarzalny kod  
identyfikacyjny typu wyrobu: \*\*  
przeznaczenie: higiena osobista  
Możliwość czyszczenia: Zgodny  
Odporność na uderzenia/  
Rozkruszalność: Zgodny  
Trwałość: Zgodny

DOP N° 207919/0020/2016

**RU**



ADEO Services -135 Rue Sadi Carnot -  
CS 00001 59790 RONCHIN - France  
16  
EN 14428:2015

Уникальный идентификационный  
код типа изделия: \*\*  
Назначение: личная гигиена  
Легкость очистки: Соответствие  
Ударопрочность/  
Мощность распыления: Соответствие  
Долговечность: Соответствие

DOP N° 207919/0020/2016

**UK**



ADEO Services -135 Rue Sadi Carnot -  
CS 00001 59790 RONCHIN - France  
16  
EN 14428:2015

Унікальний ідентифікаційний  
код виду продукції: \*\*  
призначення: особиста гігієна  
Легкість очищення: Відповідність  
Ударостійкість/  
Потужність розпилення: Відповідність  
Довговічність: Відповідність

DOP N° 207919/0020/2016

**RO**



ADEO Services -135 Rue Sadi Carnot -  
CS 00001 59790 RONCHIN - France  
16  
EN 14428:2015

Cod unic de identificare  
a tipului de produs: \*\*  
destinație: igienă personală  
Posibilitatea de curățare: Conform  
Rezistență la impact/  
Capacitate de fragmentare: Conform  
Durabilitate: Conform

DOP N° 207919/0020/2016

**EN**



ADEO Services -135 Rue Sadi Carnot -  
CS 00001 59790 RONCHIN - France  
16  
EN 14428:2015

Unique identification code  
of the product-type: \*\*  
Intended use: personal hygiene  
cleanability: Pass  
Impact resistance/ shatter properties: Pass  
Durability: Pass

DOP N° 207919/0020/2016

\*\*

**FR** Reportez-vous à l'annexe.  
**ES** Consulte el apéndice.  
**PT** Consulte o anexo.  
**IT** Consultare l'appendice.  
**EL** Ανατρέξτε στο Παράρτημα.  
**PL** Patrz załącznik.  
**RU** См. приложение.  
**UK** Читайте додаток.  
**RO** Consultați anexa.  
**EN** Refer to appendix.

\*\*

**FR** Reportez-vous à l'annexe.  
**ES** Consulte el apéndice.  
**PT** Consulte o anexo.  
**IT** Consultare l'appendice.  
**EL** Ανατρέξτε στο Παράρτημα.  
**PL** Patrz załącznik.  
**RU** См. приложение.  
**UK** Читайте додаток.  
**RO** Consultați anexa.  
**EN** Refer to appendix.

ADEO Services  
135 Rue Sadi Carnot  
CS 00001  
59790 RONCHIN - France

ТОВ «Леруа Мерлен Україна»,  
вул. Полярна 17а, м. Київ  
04201, Україна

ООО ЛЕРУА МЕРЛЕН ВОСТОК,  
141031, Московская область,  
Мытищинский район, г. Мытищи,  
Осташковское шоссе, д.1, РОССИЯ

\* Garantie 3 ans / Garantía 3 años / Garantia 3 anos / Garanzia 3 anni  
Εγγύηση 3 ετών / Gwarancja 3 lat / 3 летняя / 3-річна гарантія  
3 ani garanție / Guarantee 3 years

Made In P. R.C. 2016